



FEATURES

- 1X1 Tab-UP, 1" Long RJ45 with internal magnetics
- 10,8 or 6-pin signal pin versions available
- Available with and without LEDs
- Suitable for CAT 5 & 6 Fast Ethernet Cable or better UTP
- Internal magnetics are 100% electrically tested for HI-POT and functionality
- 350 μH minimum OCL with 8 mA bias current
- Recognized by UL 60950-1



ELECTRICAL SPECIFICATIONS @25°C -Operating temperature 0°C TO 70°C														
Part Number	Turns Ratio		LED s	Insertion Loss (dB TYP)	Return Loss (dB TYP) 100Ω±15Ω			Crosstalk (dB TYP)			Common Mode Rejection (dB TYP)		Hipot (Vrms) @60Hz	
	TX	RX			1-10 MHz	10-30 MHz	30-60 MHz	60-80 MHz	1-30 MHz	30-60 MHz	60-100 MHz	1-50 MHz		50-150 MHz
47F-1202YGD2	1CT:1CT	1CT:1CT	Y/G	-1.0	-20	-16	-12	-10	-40	-35	-30	-30	-20	1500
47F-1302GYD2	1CT:1CT	1CT:1CT	G/Y	-1.1	-20	-15	-14	-12	-35	-32	-30	-30	-20	1500

Mechanicals And Dimensions

47F-120X

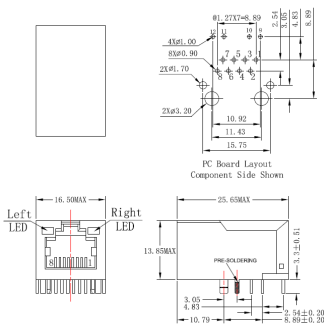

47F-121X

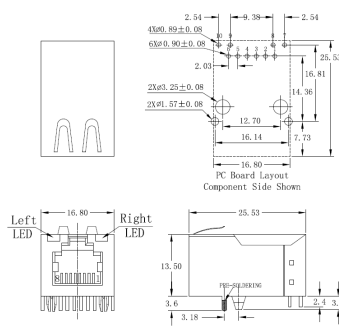

47F-130X

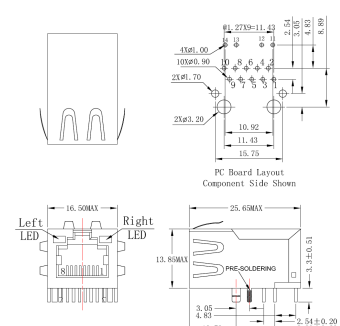

SCHEMATICS

47F-1201

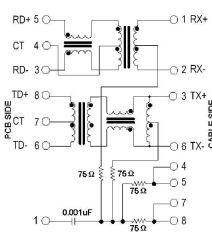

47F-1202

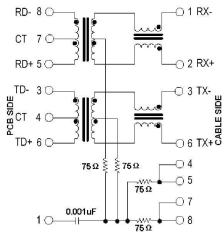

47F-1203

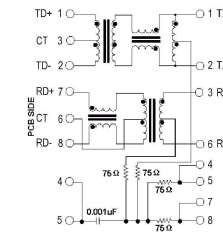

47F-1211

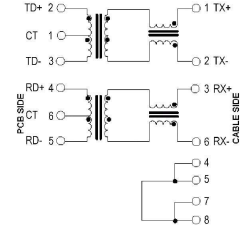

47F-1212

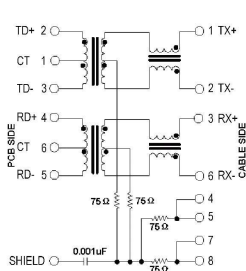

47F-1213

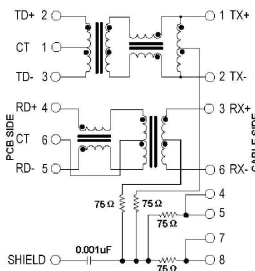

47F-1310

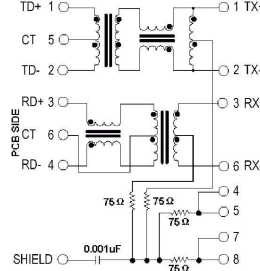

47F-1313

